

Typical Characteristics

- Wide input range: 85-305VAC/120-432VDC
- No-load power consumption $\leq 0.1W$
- Conversion efficiency: 82%(Typ.)
- Switching frequency: 65KHz
- Protection: short circuit, overcurrent, overvoltage, overtemperature
- Isolation voltage: 4000Vac
- Housing: Fully enclosed plastic, compliant with UL94 V-0
- Plug-in mounting on the PCB board
- Compliant with CE and RoHS certification

6W, wide-input-voltage, isolated regulated single-channel/dual-channel AC-DC power module



RoHS

The HAW6_S-B2 and HAW6_D-B2 series are compact, high-efficiency module power supplies offered by Huizhi Electronics.

This series of power supplies offers a wide input voltage range, AC/DC compatibility, low ripple, low temperature rise, low power consumption, high efficiency, high reliability, high safety isolation, and excellent EMC performance. The EMC and safety specifications comply with international standards EN55032 and IEC/EN61000. This series of products is widely used in various fields, including power, industrial, instrumentation, and smart home applications. When the product is used in environments with poor electromagnetic compatibility, please refer to the EMC application circuit provided by our company.

Model Number Description

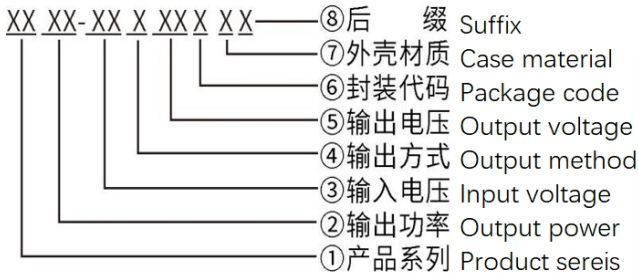

Product selection table

Cer tif ica tio n	Model number	Output specification					Maximum capacit y sexual load Max.	ripple and noise 20MHz (Max) Typ.	Efficiency @ full load, 220Vac (Typical) Typ.
		Power	Vol. 1	Io 1	Vol. 2	Io 2			
		(W)	Vo1 (V)	Io1 (mA)	Vo2 (V)	Io2 (mA)			
	HAW6-220S03B2	6	3.3	1200	-	-	2200	80	73
	HAW6-220S3V6B2	6	3.6	1200	-	-	2200	80	75
	HAW6-220S3V8B2	6	3.8	1200	-	-	2200	80	75
	HAW6-220S05B2	6	5	1200	-	-	1000	80	78
	HAW6-220S09B2	6	9	666	-	-	1000	80	78
	HAW6-220S12B2	6	12	500	-	-	680	80	80

	HAW6-220S15B2	6	15	400	-	-	470	100	80
	HAW6-220S24B2	6	24	250	-	-	220	100	80
	HAW6-220D05B2	6	+5	600	-5	600	470/470	80	78
	HAW6-220D12B2	6	+12	250	-12	250	220/220	100	80
	HAW6-220D15B2	6	+15	200	-15	200	220/220	100	80
	HAW6-220D24B2	6	+24	125	-24	125	100/100	100	80

Note 1: Due to space limitations, the above is only a partial list of products. For products not included in the list, please contact our Sales Department.

Note 2: "*" indicates models currently under development.

Note 3: Typical output efficiency values are based on measurements taken after the product has been aged under full load for 30 minutes.

Note 4: The full-load efficiency (% TYP) in the table has a tolerance of $\pm 2\%$. Full-load efficiency is calculated as the total output power divided by the module's input power.

Input characteristics

Items	Working conditions	Minimum	Typical	Maximum	Unit
Input voltage range	AC input	85	220	305	VAC
	DC input	120	310	432	VDC
Input frequency range	-	47	50	63	Hz
Input current	115VAC	/	/	0.14	A
	220VAC	/	/	0.07	
Surge current	115VAC	/	/	10	
	220VAC	/	/	20	
Leakage current	-	0.5mA TYP/230VAC/50Hz			
External insurance management recommendation value	-	1A-2A/250VAC slow-break fuse			
Hot-swappable	-	Not supported			
Remote control	-	There is no remote control			

Output characteristics

Items	Working conditions	Minimum		Typical	Maximum	Unit
Voltage accuracy	Full input voltage range Any load	Vo1	-	± 1.0	± 2.0	%
		Vo2	-	± 3.0	± 5.0	%
Line regulation rate	Rated load	Vo1	-	-	± 0.5	%
		Vo2	-	-	± 1.5	%
Load regulation	Input rated voltage 20%~100% load	Vo1	-	-	± 1.0	%
		Vo2	-	-	± 3.0	%
No-load power consumption	Input 115VAC	-	-	-	0.1	W
	Input 220VAC	-	-	-		
Minimum load	Single output	0	-	-	-	%

	Positive and negative dual co-ground output	-	-	10	%
	Positive and negative dual isolated outputs	-	-	10	
Startup delay time	Input rated Voltage (Full Load)	-	1000	-	mS
Power down hold time	Input 115VAC (Full Load)		10		mS
	Input 220VAC (Full Load)	--	60	-	
Dynamic response	25%~50%~25% 50%~75%~50%	Overshoot amplitude (%): $\leq \pm 5.0$			%
		Recovery time (mS): ≤ 5.0			mS
Output overshoot	Input full voltage range	$\leq 10\%V_o$			%
Short-circuit protection		It can be short-circuited for a long time and self-recovering			Barrier type
Drift coefficient	-	-	$\pm 0.03\%$	-	%/°C
Overcurrent protection	Input full voltage range	$\geq 150\% I_o$ is self-recoverable			Barrier type
Ripple Noise	-	-	50	100	mV
	Note: The test method for ripple and noise uses the twisted-pair test method. For specific test procedures and equipment requirements, please refer to the section below (Ripple & Noise Test Instructions).				

Note: Products with dual outputs are tested under balanced load conditions (where the rated power of the two output loads varies in equal proportion);

General characteristics

Items	Working conditions	Minimum	Typical	Maximum	Unit
Switching frequency	-	-	65	-	KHz
Operating temperature	-	-25	-	+75	°C
Storage temperature	-	-40	-	+85	
Soldering temperature	Wave soldering	$260 \pm 4^\circ\text{C}$, time: 5-10S			
	Hand soldering	$360 \pm 8^\circ\text{C}$, interval 4-7S			
Relative humidity	-	10	-	90	%RH
Isolation voltage	Input-output, test for 1 minute, leakage current $\leq 5\text{mA}$	4000	-		VAC
Insulation resistance	Input-output @ apply DC500V	100	-		MΩ
Safety standards	-	EN60950、IEC60950			
Vibration	-	10-55Hz, 10G, 30Min, along X, Y, Z			

Safety level	-	CLASS II
Housing grade	-	UL94V-0
Mean Time Between Failures (MTBF)	-	MIL-HDBK-217F@25°C > 300,000H

EMC Electromagnetic Compatibility Characteristics

Total Project	Sub-projects	Testing standards	Judgment grade
EMC	EMI	Conducted Emission	CISPR22/EN55032 CLASS B (See Figure 3 for the recommended circuit)
		Radiated Emission	CISPR22/EN55032 CLASS B (See Figure 3 for the recommended circuit)
	EMS	Radiation Immunity	IEC/EN61000-4-3 10V/m Perf. Criteria B (See Figure 3 for the recommended circuit)
		Conducted Susceptibility	IEC/EN61000-4-6 3Vr. m. s Perf. Criteria B (See Figure 3 for the recommended circuit)
		Electrostatic Discharge	IEC/EN61000-4-2 Contact ±6KV / Air ±8KV Perf. Criteria B
		Surge Immunity	IEC/EN61000-4-5 ±1KV Perf. Criteria B (See Figure 3 for the recommended circuit) ±2KV/±4KV Perf. Criteria B (See Figure 3 for the recommended circuit)
		Electrical Fast Transient (EFT) Immunity	IEC/EN61000-4-4 ±2KV Perf. Criteria B (See Figure 3 for the recommended circuit) ±4KV Perf. Criteria B (See Figure 3 for the recommended circuit)
		Immunity to Voltage Sag and Transient, Short Interruption	IEC/EN61000-4-11 0%~70% Perf. Criteria B

Package Dimensions

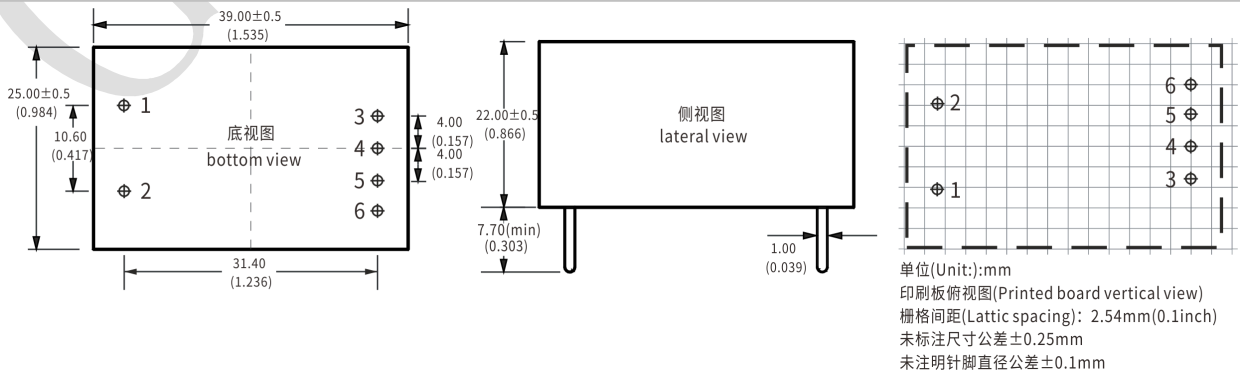

Package code	L x W x H	
B2	39.0 x 25.0 x 22.0 mm	1.535 × 0.984 × 0.866inch

Pin Definition

Pin	1	2	3	4	5
Single (S)	AC (L)	AC (N)	+Vo	NP	-Vo
	Input wire	Input neutral wire	Output positive terminal	Bare pin	Output negative terminal
Dual (D)	AC (L)	AC (N)	+Vo1	COM	-Vo2
	Input wire	Input neutral wire	Output positive terminal 1	Common terminal	Output negative terminal 2

Note: If the pin assignments of the power module differ from those in the selection guide, refer to the labels on the actual unit.

Ripple & Noise Test Instructions (Twisted Pair Me

Test Method:

1. For ripple and noise testing, use a Category 12 twisted-pair cable. Set the oscilloscope bandwidth to 20 MHz and use a 100 MHz bandwidth probe. Connect a 0.1 μF polypropylene capacitor and a 10 μF high-frequency, low-impedance electrolytic capacitor in parallel at the probe tip. Set the oscilloscope to "Sample" mode.

2. Output Ripple Noise Test Diagram:

Connect the power supply input to the input power source. Connect the power supply output to the electronic load via the fixture board. For testing, use a 30 cm ± 2 cm sampling lead to take a direct sample from the power supply output port. Select insulated wires with appropriate gauge based on the magnitude of the output current.

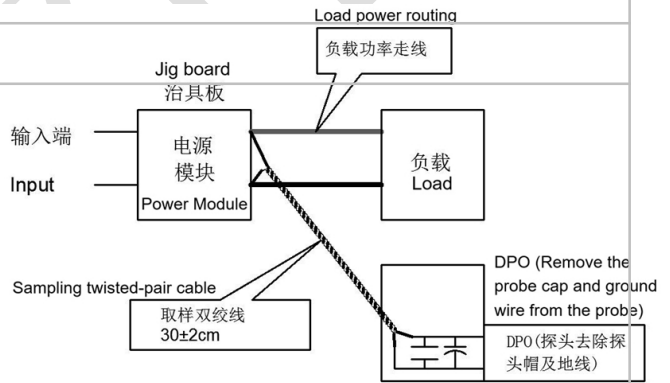

Product characteristic curve

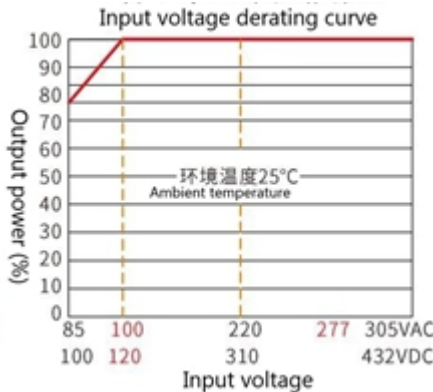
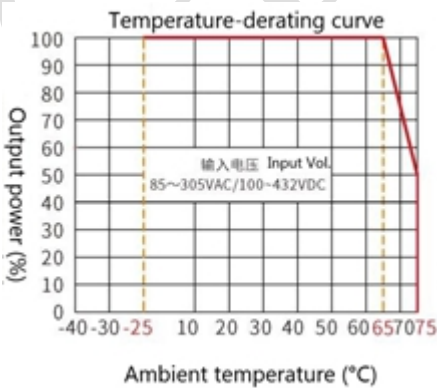

Note 1: The input voltage range is 85 - 100 VAC, 277 - 305 VAC, 120 - 140 VDC, or 392 - 432 VDC. Voltage derating must be performed based on the input voltage derating curve.

Note 2: This product is designed for use in naturally ventilated environments. Please contact us if you intend to use it in an enclosed environment.

Typical application circuit diagram and recommended parameters



图1



图2

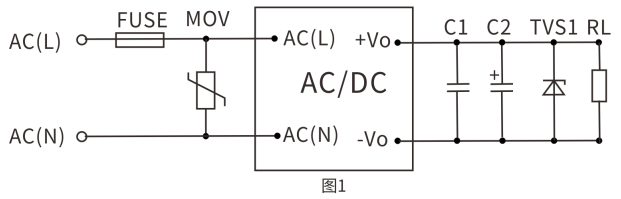

图3

For general application requirements, use the circuit recommended in Figures 1 and 2;

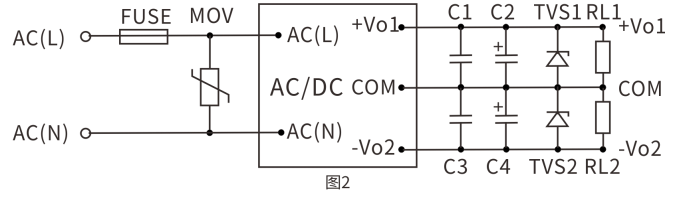
If EMC requirements apply, use the circuit recommended in Figure 3. The specific recommended values for Figure 3 are as follows:

- 1) Varistor (MOV): Recommended model: 14D-561K. Its function is to protect the module from damage during lightning surges.
- 2) Safety capacitors CY1 and CY2: 1000 pF/400 VAC;
- 3) Safety capacitor CX: 0.22 μ F/275 VAC;
- 4) Common-mode choke LCM: 20mH - 30mH;
- 5) FUSE (fuse): Mandatory; recommended specification is 2 A/250 V, slow-blow.

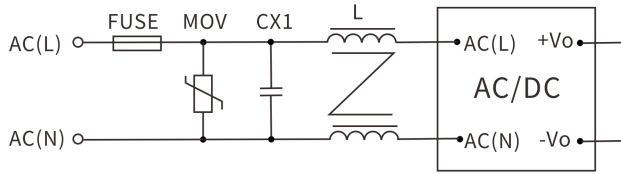
Note 1:

1. Output filter capacitors C1 and C3 eliminate high-frequency noise; 1 μ F ceramic capacitors are recommended, with a voltage rating derated by more than 80%.
2. Output filter capacitors C2 and C4 are electrolytic capacitors; high-frequency, low-resistance electrolytic capacitors are recommended, with a capacity of 220 μ F/1A output current. The voltage rating of the capacitors should be derated by more than 80%.
3. A TVS diode is recommended to protect the downstream circuitry (in case of module malfunction). Recommended 600W models: For 5V output, use SMBJ7.0A; for 9V output, use SMBJ12.0A; for 12V output, use SMBJ20A; for 15V output, use SMBJ20.0A; for 24V output, use SMBJ30.0A; for 48V output, use SMBJ64A
4. MOV stands for varistor. Recommended models: 10D561K (1000V surge) or 14D561K (2000V surge). Its function is to protect the module from damage during lightning surges.

Notes

1. The product must be used within its specified parameters; otherwise, it may be permanently damaged.
2. A fuse must be installed at the product's input terminal.
3. If the product operates below the minimum required load, we cannot guarantee that all performance specifications listed in this manual will be met;
4. If the product operates outside its rated load range, we cannot guarantee that all performance specifications listed in this manual will be met;
5. Unless otherwise specified, all data above was measured at $T_a=25^{\circ}\text{C}$, humidity <75%, with nominal input voltage and rated output load (pure resistive load);
6. All test methods for the above specifications are based on our company's standards;
7. The above specifications apply to the product models listed in this manual. Certain specifications for non-standard models may exceed the requirements listed above; please contact our technical staff directly for details;
8. We offer product customization;
9. Product specifications are subject to change without notice; please refer to the latest version of the manual published on our official website.

Contact

GDHUIZHI®

广东汇智电子科技有限公司

[Guangdong Huizhi Electronic Technology Co., Ltd.](http://www.huizhi-elec.com)

地址：广东省肇庆市端州区 11 区肇庆大道北侧厂房、办公楼(二期)3 楼

Address: 3rd floor, factory and office building (phase II) on the north side of Zhaoqing Avenue,
District 11, Duanzhou District, Zhaoqing City, Guangdong Province, China

Homepage: www.huizhi-elec.com/www.chinaebizal.com

Tel: +86 - 758 - 2566 585

E-mail: sales@huizhi-elec.com

GDHUIZHI